

BIOBASE

Blood Bank Refrigerator

User Instruction

Applicable Model: BXC

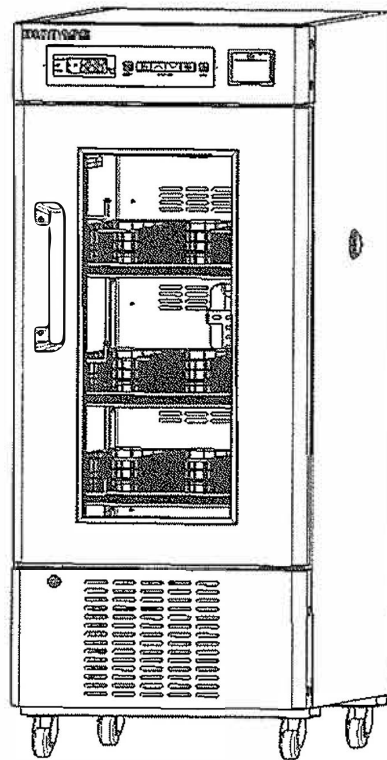

Please read the instruction carefully before use

Please keep it well for reference in the future

The product is only suitable for sale and use in the mainland of China

Statement:

Thank you for selecting, using product of BIOBASE(Shandong).For the purpose that you can use the instrument safely, conveniently as well as maintain it reasonably, please read the instruction carefully before use, and keep it well for inspection.

Any damage to the instrument caused by not using it in the "Use Environment" stated in the instruction, or damage caused by personnel who did not operate it according to the requirements in the "Safety Tips", BIOBASE(Shandong)shall bear no obligations and responsibilities.

In the use process, users must be in line with the following three points:

1. Always proper use of protective equipment (including clothes, gloves, goggles, etc.);
2. Always have good health habits, and operate in strict accordance with the product user instruction ;
3. Everyone has an obligation to be responsible for his own safety.

Due to the faster update of products of BIOBASE (Shandong), if the functions described in this instruction are different from functions of the product you purchased, the physical function shall prevail.

Safety Tips:

- If you use this machine for the first time, please read this instruction carefully.
- The blood bank refrigerator can only be operated by trained and authorized personnel.
- The maintenance of the equipment can only be done by the personnel of BIOBASE(Shandong) or agent authorized by BIOBASE(Shandong).
- If the operator encounters a situation that is not mentioned in this instruction, please contact with personnel of BIOBASE(Shandong) or agent authorized by BIOBASE(Shandong) to inquire about the correct handling method.
- Please use the accessories provided by BIOBASE(Shandong). If users use accessories made by other manufacturer, the bad consequences caused from which shall not be borne by BIOBASE(Shandong), however, users can apply to BIOBASE(Shandong) to verify whether the accessories can meet the requirements of BIOBASE(Shandong).
- The blood bank refrigerator must be inspected and maintained at specified intervals.
- The blood bank refrigerator are forbidden to store live creatures or other items that are

unsuitable for constant temperature storage.

- The blood bank refrigerator can achieve the purpose of cooling by hot and cold exchange , therefore, in order to ensure the normal operation and ventilation of the machine, the back and two sides of the cabinet shall at least 30 cm away from the wall, and the air inlet and outlet can not be obstructed.

- If the temperature in the blood bank refrigerator rises after a machine failure or power failure, can it can not be repaired within a short period of time, please remove the stored items and transfer them to other places the temperature requirements of the stored items can be achieved, do not damage the stored items.

- If the machine shall not be used for a long time, please turn off the main power switch, battery switch, to avoid damage to batteries and other components.

Contents

1.Product Diagram & Overview.....	4
2.Preparation & Precautions before Use.....	6
3. Instructions for Use.....	8
3.1Use for the First Time.....	8
3.2Temperature Adjustment.....	8
3.2.1 Button Function.....	8
3.2.2 Parameters Setting Method.....	9
3.2.3Mistakes Display.....	10
4.Daily Maintenance.....	12
4.1 Cleaning of refrigerator.....	12
4.2 Defrosting.....	12
4.3 Maintenance.....	12
5.Troubleshooting & Repair Service.....	14
6. Key Performance Indicators.....	15
6.1 Main Technical Parameters.....	15
6.2 Wiring Diagram.....	15

1.Product Diagram & Overview

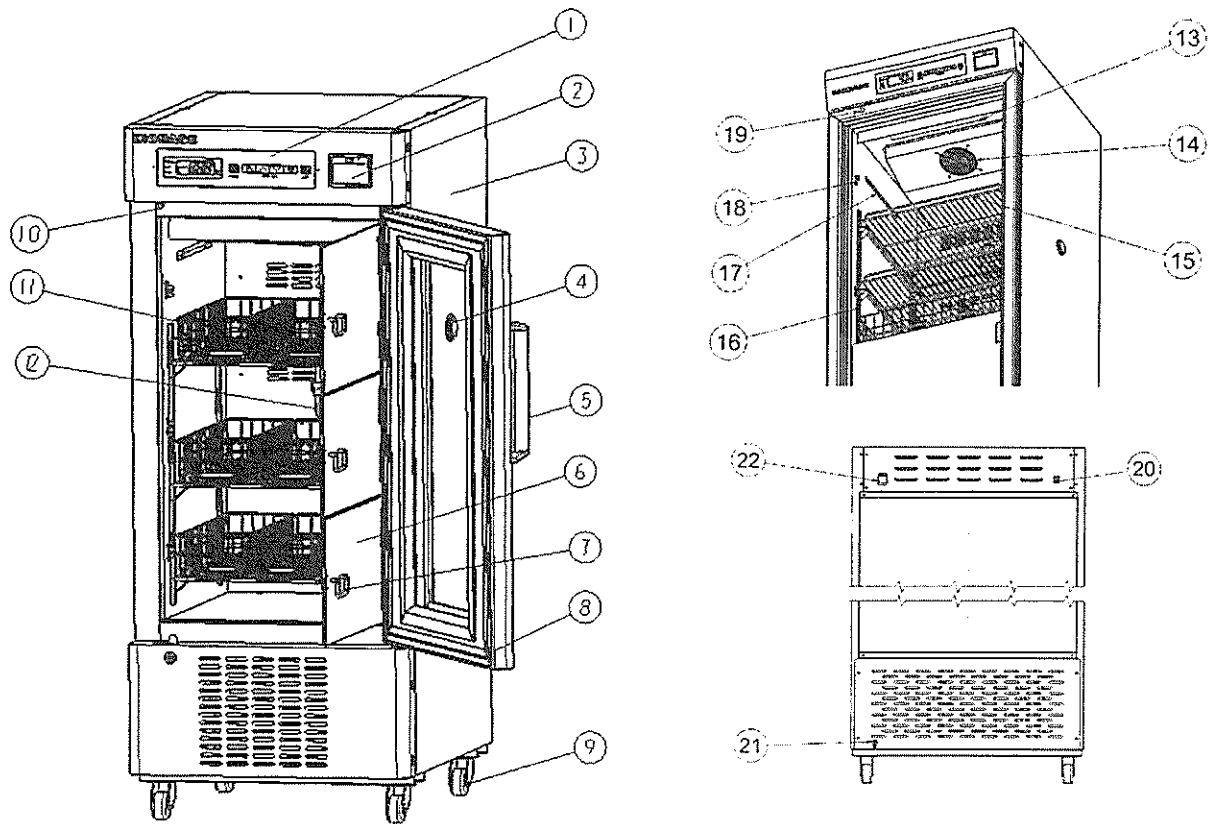

Figure 1: BXC-V160B Structure Schematic Diagram

1-Thermostat	2-Thermal printer	3-Cabinet	4- Test hole
5-Door handle	6-Inner door	7- Inner door handle	8- Outer door
9-Caster	10-Door alarm switch	11-Blood storage basket	12-Temperature sensitive box
13-Fluorescent lamp	14-Fan	15-Shelf	16- Shelf hanger
17-Load line	18-Roller touch beads	19-Door lock	20- Battery switch
21-Power cord interface	22-Main power switch		

Note: No.20-22 is the broken view of the rear part of the cabinet

Due to the improvement of the product and the different models, the actual product may be different from the schematic diagram, the physical product shall prevail!

Blood bank refrigerator can be applied to hospitals, epidemic prevention stations, blood banks, research institutes, universities, bio-pharmaceuticals, genetic engineering, enterprises and other places needing constant temperature storage. The storage temperature in the cabinet can be adjusted by the temperature button on the control panel, which is very convenient for use, and the performance is reliable.

2. Preparation & Precautions before Use

• Transportation: The machine should be lifted from the bottom, the slope can not be greater than 45 degrees, and the machine should be transported and put down lightly.

- Do not catch the door or lining as the force component.
- Remove all packaging components (including the protective foam in the cabinet).
- Please follow the packing list to check the accompanying attachments and data.
- Clean the product before use.

·Use environment requirements:

- a) Indoor use
- b) The mounting surface must be fixed, horizontal, non-combustible and can withstand the working weight of the blood bank refrigerator;
- c) It should be placed in a place not exposing to direct sunlight and away from the heat source, the environment temperature is not higher than 32 °C;
- d) For the surrounding of the blood bank refrigerator,30cm is required to be left for ventilation;
- e) It cannot be placed in the environment with temperature below 0°C;
- f) It cannot be placed in the environment with heavy moisture or subject to splash.

• In the flat ground, the blood bank refrigerator can be moved by direct push.

ⓘ Note: When pushing the blood bank refrigerator, the casters shall not bruise the power cord.

ⓘ Note: The packing base at the bottom of the blood bank refrigerator must be removed before use.

ⓘ Note: Do not immediately put items in the blood bank refrigerator whose power is just turned on, and items can be put in it after the blood bank refrigerator idles for a period of time (about 12 hours).

Normal working conditions of the equipment:

- a) Environment temperature: 10°C ~ 32°C;
- b) Relative moisture: ≤80%;
- c) The surrounding has no strong vibration or corrosive gas;
- d) The equipment must be not affected by direct sunlight and other cold and heat sources.

Precautions:

·Power supply voltage: Voltage of the equipment is 220V / 50Hz AC power, if the voltage is less than 187V or higher than 242V, an appropriate automatic voltage regulator needs to be installed;

·When using the blood bank refrigerator, a low voltage air circuit breaker and leakage

protection device need to be installed on the power;

- A dedicated independent socket must be used and it needs reliable grounding, the length of the power cord must not be extended deliberately, if the length needs to be extended, 2.5mm² above copper wire must be used, cross-sectional area of the copper wire in the wall connected to the power socket must be 4m² above;

- Flammable, explosive dangerous goods and strong corrosive acid, alkali and other items are forbidden to be put into the blood bank refrigerator;

- The key should be properly kept, to avoid children from having accident after they get the key and use it to open the door;

- Do not connect the neutral wire (N-side) of the socket with the ground wire (E-side), otherwise it will cause the refrigerator to be charged, and electric shock accident;

- Power cord cannot be bundled for use, cannot be placed under the weight, cannot be close to the compressor and other heat sources.

3. Instructions for Use

3.1 Use for the First Time

·After the package is removed, the blood bank refrigerator should be placed well in accordance with the requirements of use environment;

·Before leaving the factory, the inside of the blood bank refrigerator has been cleaned, while, we still recommend the user to scrub it with some warm water and a little amount of neutral detergent, then scrub with clean water and dry it (electrical parts cannot be cleaned and can only be wiped with dry cloth);

·Set the thermostat of the blood bank refrigerator to be 4 ° C, turn on the power, press the main power switch and the battery switch on the upper part of the cabinet's back to turn on the controller indicator, then start on the compressor after 3 minutes. After 30 minutes, the temperature in the blood bank refrigerator shall be decreased dramatically, indicating that the cooling system is working properly, test to the machine is over;

·If it is used for the first time, it is recommended that the temperature inside the refrigerator should firstly be decreased to the use temperature and then place the items to be stored in it. If there are many items to be stored, it is recommended to store them by three times. The storage time for the next time should be after the temperature in the refrigerator decreases to the set time. If the user stores too many items for one time, the items may be damaged because the refrigerator cannot be decreased to the set time for a long period;

·In order to reduce energy consumption, the number of door opening and opening time should be minimized.

3.2 Temperature Adjustment

3.2.1 Button Function

Electronic thermostat is installed in the control panel of the blood bank refrigerator, after the power is turned on, the digital display can display the actual temperature inside the blood bank refrigerator.. The thermostat control panel is shown below:

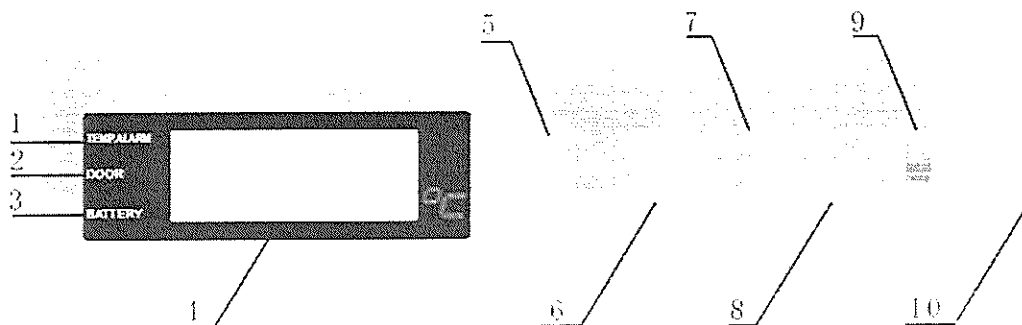



- 1-Temperature alarm mark 2-Door ajar alarm 3-Battery Status
- 4-Inside Temperature display 5-Mute 6-Set 7-UP 8-Down
- 9-Print Button 10-Lamp Switch mark



Under the normal use state, it is recommended not to adjust the set temperature deliberately, otherwise, it would lead to product's high temperature (AH) or constant temperature (AL) alarms. At this time, adjust the alarm values of the high temperature and constant temperature (AH, AL) at the same time.

Mute button: When the user needs to cancel the alarm sound prompt, the user can press the mute button to cancel the sound prompt, but the alarm indicator and alarm code will be continued to display until the alarm state is released.

Print button:

Under normal working state, press the print button  for about greater than 5 seconds, the user can print the current temperature.

Under normal working state, press the  and  simultaneously for 3 seconds to view the time.





When the time is being viewed, press the  and  simultaneously for 1 second to return to the normal display state

If the refrigerator needs to be adjusted because of some special requirements, please call the after-sales service or the equipment can be adjusted by professional maintenance personnel.

Note: Generally, the high and low temperature alarm values are in the range of set temperature 2 °C ~ 6 °C.

3.2.2 Parameters Setting Method

When the blood bank refrigerator is powered on, the display screen can display the current temperature in the refrigerator, if the set time needs to be adjusted, eg, if the originally set temperature is 2 °C, but now it needs to be adjusted to 4 °C, please follow the steps below:

No.	Button Operation	Display
1		Display the temperature in the refrigerator
2	Press the set button  for 3 seconds	Display the initially set value 2°C, and flashing
3	Press the increase button 	The digital is increased
4	Press the decrease button 	The digital is decreased
5		The temperature is 4°C
6	Press the set button  for 3 seconds	Save the setting, display the temperature in the refrigerator

Note: It is recommended that users do not arbitrarily set parameters, however, if the parameters need to be changed, please contact after-sales of BIOBASE(Shandong) and dealers for setting.

Notes: When working normally, simultaneously press the down-regulation key and print key for 5 seconds, enter the page of setting time parameter value, the default page displays t (min). The corresponding parameters of H (hour), D (day), M (month), and Y (year) were displayed respectively after press the up-regulation key. Select the parameters that needed to be adjusted, press the set key and the digital tube flickers, adjust the parameters by pressing the up-regulation key or down-regulation key, then press the set key to save the current parameter value.

3.2.3 Mistakes Display

When the cabinet temperature display probe has short circuit, open circuit, failure, or the connection is not correct, the display screen shall display "E0", when the cabinet temperature control probe has short circuit, open circuit, failure, or the connection is not correct, the display screen shall display "E1". At the same time the thermostat buzzer will sound an alarm, the display shows the corresponding alarm parameters (E0, E1).

After the power is turned off, the control function of the controller is disabled, the controller backup power supply can provide power failure alarm. Power-down symbol "Pd" and the real-time temperature in the refrigerator can be alternately displayed, when the real-time temperature in the refrigerator exceeds the high temperature alarm value, the high temperature alarm light will flash continuously until the backup power supply is exhausted.

Recommendation: when determining whether the temperature probe has mistakes, the user should cut off the power, firstly check whether the connection wire of the temperature sensing probe is loose. Please contact professional after-sales staff of BIOBASE (Shandong) or dealers to deal with.

 **Note: If the internal code is displayed when the user is adjusting the thermostat, please wait 1 minute, and the operation cannot be conducted until the temperature in the refrigerator is displayed again, so as to avoid the blood bank refrigerator has failure due to changes in control parameters.**

When the blood bank refrigerator is temporarily stopped for running because of power outage or other failures, temperature in the refrigerator will increase, after 1 hour, the temperature may increase from 4°C to 15°C, if the power supply cannot be restored within a short period, the stored

items must be removed and transferred to other refrigerator whose operation state is normal for storage, to avoid damage to the stored items.

Before the items are placed in the refrigerator for storage, please make sure whether it is suitable for storing in the time set by the user, so as to avoid damage to the items due to the unsuitable temperature of the equipment.

Due to the inertia of the refrigeration, there is some difference between the temperature in the refrigerator and the set temperature, and the temperature may be different with the use environment and set temperature, and such phenomenon is normal.

4. Daily Maintenance

In daily maintenance, to prevent electric shock or personal injury, please make sure to cut off the power supply before making any repair or maintenance to the equipment, and make sure that the surrounding pills or suspended particles cannot be inhaled into the equipment when it is under maintenance, otherwise it will harm your health, besides wear dry gloves to protect your hands .

4.1 Cleaning of Refrigerator

·The blood bank refrigerator should be cleaned once a month. Regular cleaning can keep the appearance of the refrigerator new;

·Use a dry cloth to wipe away the dust on the shell, inside and all accessories of the refrigerator. If the blood bank refrigerator is dirty, use neutral detergent to clean and then wipe the detergent with a cloth soaked in water;

·Do not pour water on the shell, inside of the refrigerator, otherwise it may damage the electrical insulation and cause a malfunction;

·In the rainy season, the surface of the glass door is easy to condense water vapor, or dripping phenomenon, please dry with a dry cloth at the appropriate time, the above-mentioned phenomena cannot affect the normal use.

4.2 Defrosting

The blood bank refrigerator is air-cooled frost-free refrigerator, and defrosting is not needed. In summer, when the humidity is serious, the opening frame part may have condensation phenomenon, which is normal, and it is recommended to dry with a dry cloth.

4.3 Maintenance

·Do not place heavy objects on the door or top cover of the blood bank refrigerator, to prevent the door or top cover from being deformed.

·After a period, the blood bank refrigerator should be cleaned and maintained

·Wipe the inner and outer surfaces of the blood bank refrigerator with a warm, wet and soft cloth.

·When the dirt is serious, you can use utensils-used neutral detergent to wipe, and then wipe the water stains with cleaned soft cloth.

·Once the refrigerator is used, it is recommended to used it continuously.

ⓘ **Note:** Do not spill water directly on the blood bank refrigerator, so as to avoid damage to electrical components' insulation performance and metal rust. Do not use hot water and corrosive cleaning agents or organic solvents, etc to clean the blood bank refrigerator, or clean with hard brush, wire brush. Do not allow children to play games with the refrigerator.

5. Troubleshoot & Repair Service

Some abnormalities in the blood bank refrigerator are caused by improper use. Before commissioning to repair, please follow the following table to check and exclude by yourself firstly.

Failures	Causes & Solutions
The blood bank refrigerator does not work	<ul style="list-style-type: none"> · Whether the power plug has power? · Whether the power plug is plugged on or loosened? · Whether the power fuse is disconnected? · Whether the power supply voltage is too high or too low?
The compressor does not run	<ul style="list-style-type: none"> · Whether the temperature setting is correct?
The temperature continues to drop after reaching the expected value	<ul style="list-style-type: none"> · Whether the temperature setting is correct?
The temperature does not reach the set value	<ul style="list-style-type: none"> · Whether the fan has stopped to run · Whether the door is closed well or the number to open the door is too many? · Whether the items placed in one time is too many and the air duct is blocked? · Whether the environment temperature is too high?
The noise is too loud	<ul style="list-style-type: none"> · Whether the refrigerator is placed on a flat ground? · Whether the refrigerator touches walls? · Whether the refrigerator immediately enters into operation state after it is started?

If you cannot determine the cause of the failures, or if you are unable to troubleshoot the problem, please contact with the local or nearby special maintenance service department established by use, and tell them your name, address, model, purchase time, failure phenomenon, etc, professional engineers shall serve for you heart and soul.

6. Key Performance Indicators

6.1 Main Technical Parameters

Model	Climate Type	Temperature in the Refrigerator (°C)	Effective Volume (L)	Rated Voltage (V~)	Rated Frequency (Hz)	Refrigerant	Dimensions (W*D*H)
BXC-V160B	N	4±1	160	220	50	R134a	530×660×1287mm

6.2 Wiring Diagram

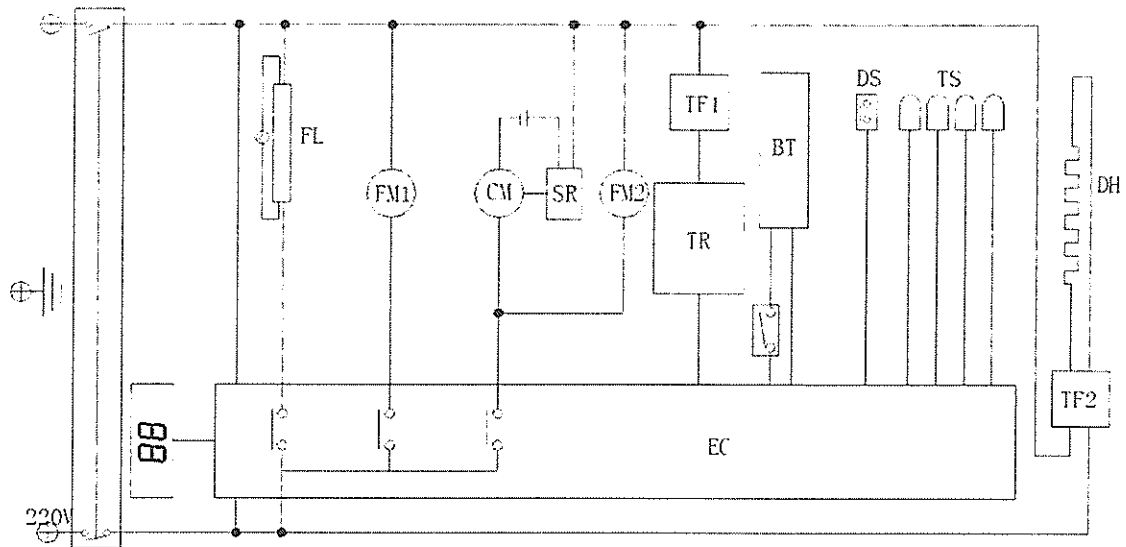

FL= Fluorescent Lamp

CM= Compressor

TF1=Adapter

DS= Door Switch

TF2= Transformer

FM1= Evaporative Fan

SR= Starting relay

TR= Printer

TS= Temperature Probe

FM2= Condensing Fan

EC= Control Circuit Panel

BT= Battery

DH= Door Heating Film

Packing list

Model	User Instruction	Key	Shelf	Blood storage basket
BXC-V160B	1	2	3	9

1
2
3
4
5
6
7
8
9
10
11
12
13
14
15
16
17
18
19
20
21
22
23
24
25
26
27
28
29
30
31
32
33
34
35
36
37
38
39
40
41
42
43
44
45
46
47
48
49
50
51
52
53
54
55
56
57
58
59
60
61
62
63
64
65
66
67
68
69
70
71
72
73
74
75
76
77
78
79
80
81
82
83
84
85
86
87
88
89
90
91
92
93
94
95
96
97
98
99
100

BIOBASE BIODUSTRY(SHANDONG) CO., LTD.

ADDRESS: NO. 51 SOUTH GONGYE ROAD, JINAN, SHANDONG PROVINCE, CHINA

TEL: +86-531-81219803 FAX: +86-531-81219804

EMAIL: EXPORT@BIOBASE.CN

